

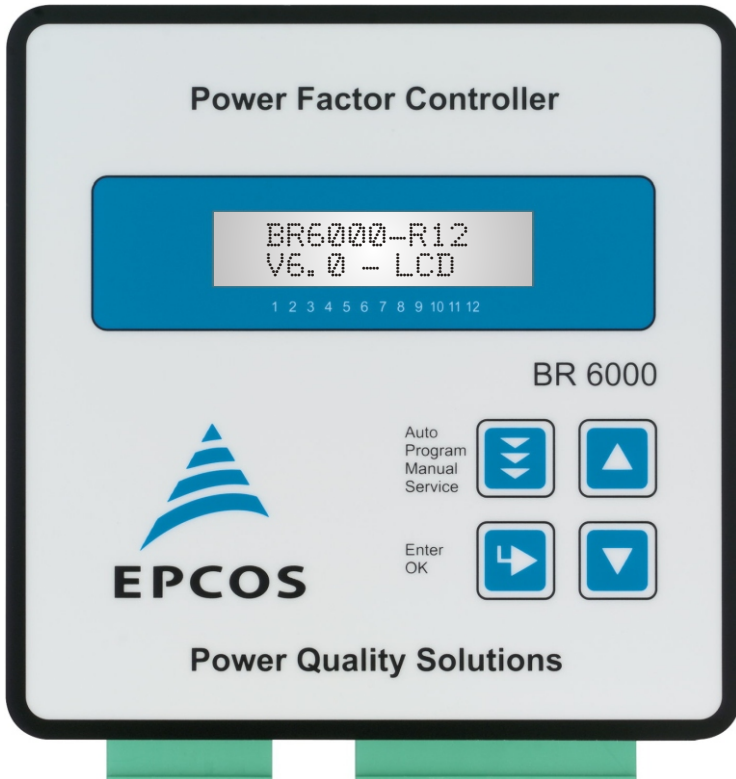

Power Factor Controller
BR6000



Manual
Version 6.0

EPCOS AG
Power Quality Solutions
P.O. Box 80 17 09
D-81617 Munich
St.-Martin-Str. 53
PFC-Hotline
Tel. ++49 89 636 - 25533
Telefax ++49 89 636 - 22748
internet: <http://www.epcos.com>

Screens of Windows-software "BR7000-Soft"

Software and description at CD - included in delivery with "BR6000-R12/S485"



Software supports BR6000/ BR7000



Display-Mode

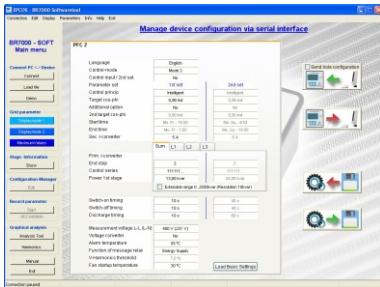

Configuration manager

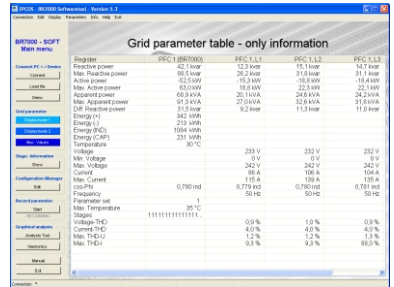

Grid parameter table

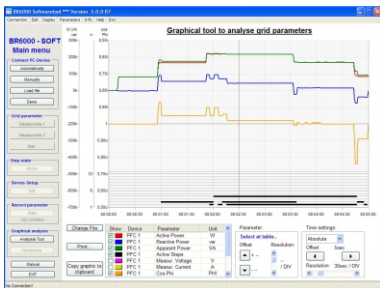

Analysis tool

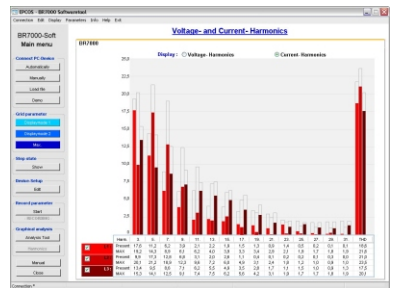

Harmonics diagram

CAUTIONS:



1. High voltage !
2. BR6000 may only be used indoor !
3. Make sure that the discharge time set in controller matches capacitor discharge time !

CONTENTS

Section 1	General / type series and accessories	3
Section 2	Installation of the controller / connection diagram	5
	2.1 Current measurement	6
	2.2 Programming of phase-correction	6
	2.3 Alarm output / error messages	7
Section 3	Operating modes	7
Section 4	Automatic operation / display functions	8
Section 5	Programming	9
	5.1 Automatic initialization	9
	5.2 Manual programming	10
	5.3 Programming lock	13
Section 6	Manual operation / Programming of fixed stages	14
Section 7	Service menu, Test run	15
Section 8	Expert mode	16
	8.1 Expert mode 1	
	8.2 Expert mode 2	18
Section 9	Control principle	19
Section 10	Interface	20
Section 11	Initial operation	20
Section 12	Maintenance and warranty	20
Section 13	Troubleshooting	21
Section 14	Technical data	22
Annex:	Annex 1 Table of control series	23
	Description of control-series editor	
	Annex 2 Default settings	24
	Annex 3 Controller coupling	25
	Annex 4 Mixed dynamical compensation	26
	Annex 5 Application MM16000	27
	Annex 6 MODBUS protocol	28
	Annex 7 Operating diagram (fast programming)	29

Section1 General

The power factor controller BR6000 is a modern control device of innovative design with a variety of functions - now in version 6.0

It is designed for a measuring voltage of 30...525V (L-N) or (L-L) and a supply voltage of 110...230VAC.

It features a user interface with a menu-driven display in plain text for maximum ease of operation. Straightforward symbols and alphanumeric displays in the language of the country of use (ten languages) combine maximum ease of handling with convenient presentation of results.

Display of various grid parameters, storage of various values and a test run option make it easy to analyse errors and monitor the system.

An automatic initialization is available which will reduce the commissioning to a minimum.

Main features:

- Six or 12 switching outputs (depending on the type option for 7 or 13 outputs)
- Twenty pre-programmed control series with a self-optimized intelligent control response
- Control-series editor for user-defined control series
- Complete menu-guided operation and display
- Illuminated graphic display with 2 x 16 characters
- Four-quadrant operation
- Automatic initialization
- Display of various line parameters (V, I, F, Q, P, S...)
- Display of voltage and current harmonics
- Display and monitoring of temperature
- Monitoring of the individual capacitor power values
- Storage of maximum line-parameter and switching-operation values as well as of the turn-on times of individual capacitor contactors
- Manual / automatic operation
- Programming of fixed stages and the option of skipping individual outputs
- No-voltage turn-off
- Error detection for various states and interference-message output
- Complete 2nd parameter set programmable / switchable
- Test run of PFC system with error analysis
- Switchboard-integrated housing 144x144x55 mm

Type series and accessories

BR6000-R6	6 relay outputs, 1 alarm relay
BR6000-R12	12 relay outputs, 1 alarm relay
Option /S485	Interface RS485 Additional user programmable message relay Input for second parameter set, controller coupling possible
Accessories	- MMI6000 / MMI7000 - MultiMeasuringInterface (for measurement of inherent current of capacitor bank) - Interface converter "RS485 to USB" for PC-connection - Interface converter "RS485 to RS232" for older PCs - DataLog SD

The controller is supplied as standard for an operating voltage of 110...230 VAC (+-15%), a measuring voltage of 30...525 VAC (L-N) or (L-L) and a measuring current of 5A or 1A. A voltage converter is required for different operating voltages.



Caution!
Voltages which exceed the specified voltage range can damage the device!

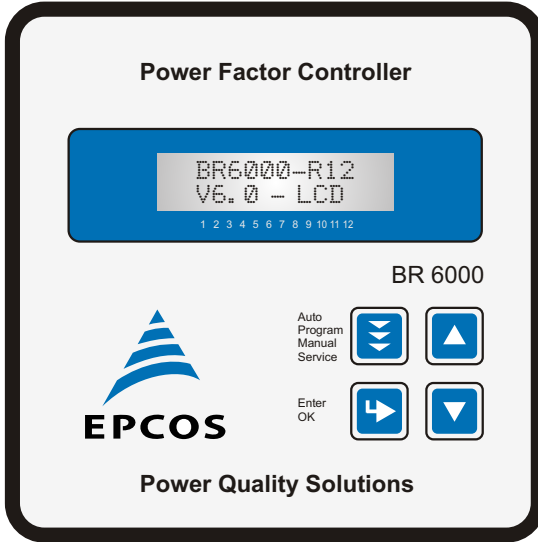

Fig.1 BR6000 front view

- Operating mode
- Automatic
 - Programming
 - Manual operation
 - Service
 - Expert mode



Enter / OK
 Confirm and store values



Increase selected parameter



Reduce selected parameter

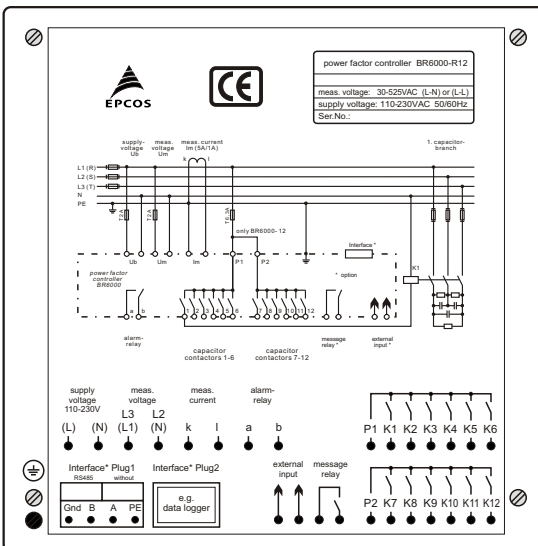

Fig. 2 BR6000 rear view

Section 2 Installation and connection of the controller

The BR6000 is designed to be incorporated into the front panel of a PFC-cabinet. It requires a switchboard section of 138 x 138 mm to DIN 43700/ IEC 61554. The controller is inserted from the front and is attached by means of the appended clamps. The controller may be inserted only by qualified technicians and must be operated in accordance with the specified safety regulations.

Before the BR6000 is connected up, all leads and cables must be checked to ensure that no current is flowing through them and the current converter must be short-circuited. Care should be taken to ensure that the measuring voltage and current are in the correct phase position. The measuring-current circuit must be wired with copper leads of 2.5mm². The connection should be set up as shown in Fig. 3. The specified safety regulations must be observed.

The measuring voltage may lie in the range from 30 - 525 VAC and can be connected between L - N (default) or between L - L (programming of phase correction needed)

The operating voltage is 110...230 VAC +/- 15% and can be connected between L - N or L-L (depending of the grid).



The coil voltage for the capacitor contactors and the measuring voltage must be drawn from the same phase conductor, as only the measuring voltage is monitored. (Protection against direct reconnection of the capacitor contactors in the event of momentary single-phase power failure)

Fig. 3: BR6000 Connection plan

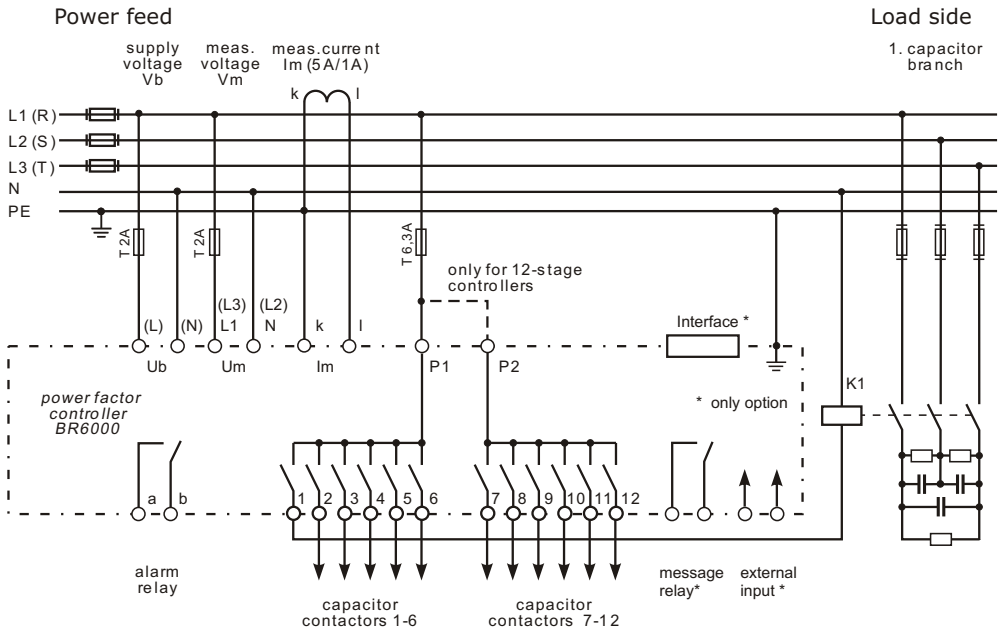

2.1 Current measurement

When installing the current converter, care should be taken to ensure that the load current flows through it. The outputs of the compensation network must be installed behind the current converter (in the direction of current flow). If the BR6000 is connected up via sum-current converters, the overall conversion ratio is entered.
Current converter clamps should be grounded on one side!



Caution !
Current converter clamps should be grounded on one side !

Example:
C.converter 1: 1000/5A
C.converter 2: 1000/5A
Sum-current converter: 5A+5A/5A

C.converter ratio is: 2000/5A

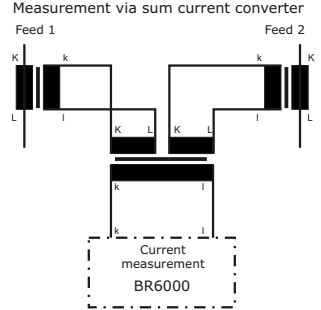

2.2 Programming of phase-correction - e.g. connection directly L-L (400V)

Adjustment of phase-correction between voltage and current in the meas. system is done in expert mode 1 (page 17)

Example :

Meas.current: L1
Meas. Voltage L3-L2
Phase U/I [90°]

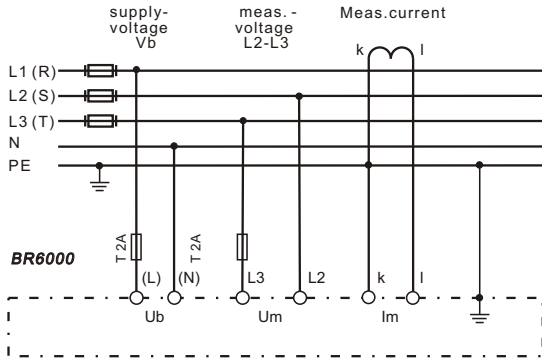

using	meas. current	meas. voltage	phase-angle
Preset:	L1	L1 - N	0°
	L1	L1 - L2	30°
	L1 (k<->l)	L2 - N	60°
	L1	L3 - L2	90°
	L1	L3 - N	120°
	L1	L3 - L1	150°
	L1 (k<->l)	L1 - N	180°
	L1 (k<->l)	L1 - L2	210°
	L1	L2 - N	240°
	L1	L2 - L3	270°
	L1 (k<->l)	L3 - N	300°
	L1 (k<->l)	L3 - L1	330°

2.3 Alarm output / error messages

The alarm contact is closed in normal operation and opens in the event of a fault. The relevant fault is simultaneously shown on the display in plain text (alternating with the standard display in automatic operation). The following fault messages are displayed:

UNDER-COMPENSATED missing reactive power	Display and relay output
OVER-COMPENSATED	Display and relay output
OVERCURRENT	Display and relay output
MEASURING VOLTAGE ?	Display and relay output
OVERTEMPERATURE	Display and relay output
OVERVOLTAGE	Display and relay output
UNDERVOLTAGE	Display and relay output
HARMONICS	Display and relay output

Additionally several messages for different operation states are generated. An individual adjustment resp. suppression of particular messages is possible in expert mode 2. During suppression, the indication of the message in the display, a possible release via alarm-relays and effects on the controlling process will be prevented.

Section 3 Operating modes

When the operating voltage is switched on, the BR6000 briefly displays its designation and software version, then changes to its normal operating status (automatic operation). The active cos-phi value is always displayed in the upper line and the currently connected capacitors are shown as symbols in the lower line (operating display).

Automatic operation

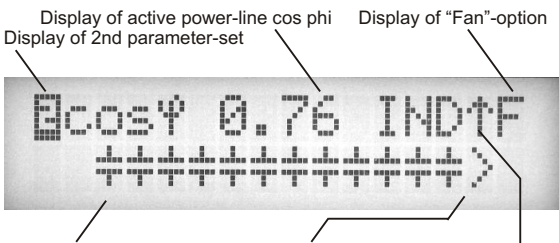

- The control direction is symbolized by a closed arrow
- ▶ Connecting-in
- ◀ Connecting-out
- The connecting-in arrow is always located after the maximum possible number of stages (end stop)
- > An open arrow indicates that the required blocking time (discharge time) is running before an impending switching step
- ▶▶ A double arrow symbolizes fast switching of several branches

- ▶ By pressing the cursor buttons, the display of capacitor stages can be changed:
- ▼

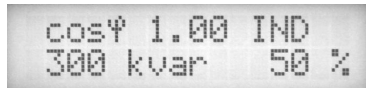

Display of activated stages in kvar and in percent of total output of PFC system

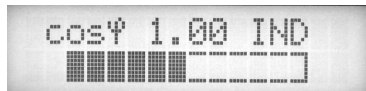

Display of activated stages as bar-graph display in percent of total output of PFC-system

The power values of the individual capacitors are monitored constantly. **If a capacitor is defective or if the deviation from the rated power is excessive, the corresponding capacitor is displayed inversely.**

Repeated pressing of the "Operating Mode" key takes the user to the various menus in sequence: **Automatic operation - Programming - Manual (manual operation)- Service - Expert mode** and back.

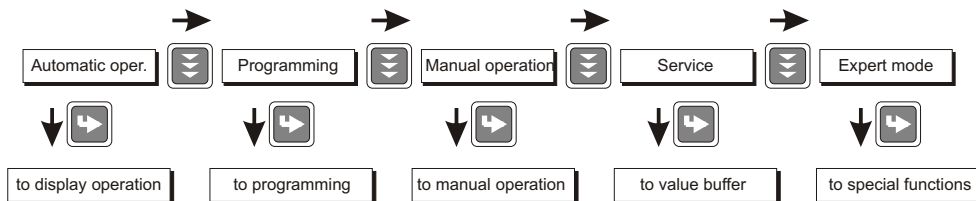

Section 4 Automatic operation - display of network parameter

The BR6000 is set to automatic operation as standard (not AUTO-INIT). Capacitor stages are then automatically connected in or out in order to reach the target power factor. This happens when the required reactive power exceeds the value of the smallest capacitor stage.

In automatic operation, various network parameters can be displayed by repeatedly pressing the "ENTER" key:



Action	Display
ENTER	1 LINE VOLTAGE in V /%
ENTER	2 APPARENT CURRENT in A /%
ENTER	3 REACTIVE POWER in kvar /%
ENTER	4 ACTIVE POWER in kW /%
ENTER	5 APPARENT POWER in kVA /%
ENTER	6 DIFF. kVAR TO TARGET COS
ENTER	7 FREQUENCY in Hz
ENTER	8 TEMPERATURE in °C / °F
ENTER	9 HARMONICS (3.-19) V / %, I / % Selection via arrow-keys
ENTER	10 THD-V, THD-I in %
ENTER	11 Comp. power (only with MMI6000)
ENTER	12 ENERGY in kvarh/ kWh (+/-) reset in: Service / max.value reset
ENTER	Software version
ENTER	Return to: 1

The power value specifies the total power (3-phase) assuming symmetrical load. If no key is pressed for 60 seconds, the display automatically returns to the operating status!

Section 5 Programming

Pressing the "Operating mode" key once takes the user from automatic operation to **Programming** mode. Parameter 1 (I-CONVERTER) is reached by pressing "ENTER".

The upper display always shows the parameter and the lower one the set value. The values are changed by pressing the \uparrow / \downarrow keys. Subsequent pressing of the "ENTER" key stores the value and takes the user to the next parameter.

Description of the parameters: **See the next page**

To quit programming mode in any step, press the "Operating mode" key.

5.1. Automatic initialization (not usable in case of coupling controllers)

With the automatic initialization the BR6000 will automatically recognize the parameters of the PFC-system. It also serves as plausibility check and storage of these parameters - the user only has to make very little or even no adjustments.

Start of the initialization process is done from the menu point "PROGRAMMING" by pressing the button " \uparrow "

AUTO-INIT [YES] to be confirmed with pressing the ENTER button.

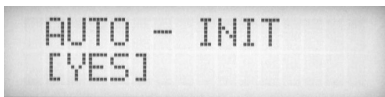

If the values of the current transformer OR the value of the first stage of the PFC-system are known, they should be entered here. This later enables a display of all values of the net in the correct electrical term. If no value is programmed (selection: unknown), values of current and output can later only be indicated as percent.

After entering of the a.m. values (selection via " \uparrow / \downarrow " buttons, confirmation with ENTER) the automatic test-run of the BR6000 is performed.



3 test-runs will be performed during which all stages are being switched on and off. All necessary parameters are collected, evaluated and stored. Under certain circumstances 3 additional test-runs may be required for a proper initialization.

After successful finalization of AUTO-INIT the BR6000 will switch to normal operation.

In case of recognition of any discrepancies (plausibility) or of inaccurate connection, the detected error will be displayed in plain text after finalization of AUTO-INIT and can be eliminated. (see possible error messages at the end of the manual). AUTO-INIT may be repeated then.

NOTE: If the BR6000 has been put into operation successfully by AUTO-INIT with all values unknown, some values will be shown as "?????" and this can not be changed. If a new programming is required, a reset is needed before: Programming/Basic settings [YES]

5.2. Manual programming (program menu)

LANGUAGE SELECTION: This selects the language of the operating menu (German, English, Spanish, Portuguese, French, RU, Cz, NL, PL, TR)

1 I-CONVERTER PRIM: [5...13000]A

This selects the primary current of the current converter. Adjustment is via the \uparrow / \downarrow keys. Save and continue with ENTER

2 I-CONVERTER SEC: [5 or 1]A

This sets the secondary current of the current converter
Selection via \uparrow / \downarrow . Save and continue with ENTER

3 END STOPP: [6/7 resp. 12/13] switching to 7/13.stage in expert-mode 2
By setting the end stopp, the number of active capacitor branches is matched to the respective capacitor bank. This is done via the \uparrow / \downarrow keys. The visible symbols of the capacitors correspond to the connected outputs. The maximum possible number of capacitor branches is pre-set at the works (BR6000-R12:12 branches).
Save and continue with ENTER

4 CONTROL SERIES: [1...20 + E]

The ratio of the capacitor branch power determines the control series, the power of the first capacitor always being assigned the value 1. The control series required for the compensation network is again selected via the \uparrow / \downarrow keys. If the required control series should exceptionally not be present (Annex 1), the user may define a special one (control series "E"). More on this point in the control-series editor in Annex 1.

5 CONTROL PRINCIPLE: The control preference may be selected here:

SEQUENTIAL connection

LOOP connection

INTELLIGENT loop connection (default setting)

COMBINED CHOKE

See Section 9 for an explanation of the various control modes.

Selection with \uparrow / \downarrow keys. Save and continue with ENTER

6 POWER 1. STAGE: [0.01 ... 255.99] kvar

To determine the controller's response sensitivity, the dimensions of the network's smallest capacitor (stage 1) must be known. They are entered in two steps in kvar. The integral kvar values (before the comma) are initially selected via the \uparrow / \downarrow keys and saved with ENTER. The positions after the comma are then selected, again via the \uparrow / \downarrow keys. If the response sensitivity of the BR6000 is being undercut, a warning will occur (indication of "!" in the display)
Save and continue with ENTER

7 TARGET COS PHI: [0.1 ind ... 0.1 cap]

By setting the target cos phi, the power factor to be attained via the PF correction is defined. It is also set via the \uparrow / \downarrow keys.

NOTE: switchover to display as TANGENT PHI - possible on request!

8 MEASURING VOLTAGE [30 ... 525]V

Programming the measuring voltage of the system.

The values programmed here always refer to the voltage at the clamps of the BR6000 !

The voltage is selected via the \uparrow/\downarrow keys. Save and continue with ENTER.

9 V - CONVERTER RATIO [NO / 230V ... 380kV]

When a measuring-voltage converter (e.g. for HV- measurement) is used, its conversion ratio should be programmed here.

(Input of prim.voltage is here, sec. voltage is automatically from item 8)

Selection via the \uparrow/\downarrow keys. Save and continue with ENTER.

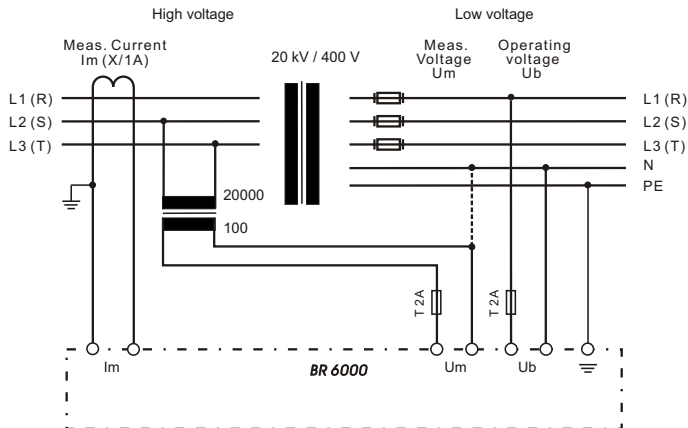

10 CONNECTING TIME

This refers to the time between connecting the capacitors to increase the momentary network capacitance. It should be noted that in practical operation the real connection time is affected by the discharge time (locking time).

Setting range: 1 sec. ... 20 min. (long time for HV- networks)

Default setting: 40 sec.

Selection is performed via the \uparrow/\downarrow keys. Continue with ENTER

11 DISCONNECTING TIME

This refers to the time between disconnecting the capacitors to reduce the momentary network capacitance.

Setting range: 1 sec. ... 20 min. (long time for HV- networks)

Default setting: 40 sec.

Selection is performed via the \uparrow/\downarrow keys. Continue with ENTER

12 DISCHARGE TIME

This is the time for which an individual output is blocked between connecting and disconnecting. This blocking time has priority over connecting and disconnecting times. It depends on the capacitor discharge rating and thus is specified by the compensation network. The discharge time of a conventional network without additional fast-discharge resistors or chokes should be set to no less than 40 seconds. For setting of a second discharge time see 'Expert Mode' point 10

Setting range: 1 sec ... 20 min. Default setting: 60 sec.

Selection is performed via the \uparrow/\downarrow keys. Continue with ENTER

13 ALARM TEMP [50...85]°C

The alarm temperature programmed here is the temperature at which the capacitor stages are disconnected in steps. The controller's **alarm relay** responds after ten minutes. At the same time the display shows the cause of the alarm (over-temperature). If the temperature drops again, the required branches are automatically re-connected in steps.

The selection is performed with the **↑/↓** keys. Save and continue with **ENTER**.

14 MESSAGE RELAY (available not in each type)

The message relay can be programmed for one of the following options as required:

"OFF": Relay not used

"External": The relay switches if an external input signal (110...230 VAC) is sent to the "external" input. This function may be used to directly compensate a larger load, for example - the required 40-second reconnection delay is already integrated.
Display: Capacitor symbol at the top right of the first line.
When this function is selected, the input cannot be used for the signal '2nd parameter set' and the output cannot be used for the fan.

"Fan": Relay switches the external cabinet fan.
(Default) The switching threshold can be programmed under point 15.
Display: **"F"**

"Supply": Message when active power is supplied. Display: **"S"**

"Undercurrent": This message appears whenever the measuring current is not reached. Display: **"U"** The signal is generated when the value drops below the response sensitivity of the controller.

"Harmonics": This message appears when the limit of the total harmonic distortion THD-V is exceeded. This value can be set under "27 Harmonics" in%

"Remote control R1": Master-Slave-Coupling of 2 controllers via remote control input, R1= Controller is configured as controller 1 (master)

"Remote control R2": Master-Slave-Coupling of 2 controllers via remote control input, R2= Controller is configured as controller 2 (slave).
When this function is selected, the input cannot be used for the signal '2nd parameter set' and the output cannot be used for the fan.

Selection is via the **↑/↓** keys. Save and continue with **ENTER**.

15 FAN TEMP* [15...70]°C

Input of the switching threshold for the fan. Only active if option 'Fan' is selected (temperature input as described under point 13)

16 External Input * [NO / 2nd PARAMETER SET / EXTERNAL ERROR / COUPLING]

* only applicable for controllers with option /S

* not active if message relay is programmed as "EXTERNAL" or "REMOTE CONTROL"

2nd PARAMETER SET:

As a standard, the values of the 2nd parameter set are equal to the values of the normal parameters. By changing particular parameters, for example the cos-phi can be switched. Other possible applications may be switching of current transformer or switching of switching times.

By triggering of a (110 ... 230 VAC) signal at the external input, the 2nd parameter set will be activated with the following values:

17. I-converter prim, 18. I-converter sec. 19. End stopp, 20. Control series,
21. Control principle, 22. Power 1.stage, 23. Target cos-phi, 24. Switch-on time,
25. Switch-off time, 26. Discharge time



The values of the 2nd parameter set and the indication of activation is marked with this symbol in the display.

EXTERNAL ERROR:

In this mode an external triggering signal (110...230VAC) will switch-off all stages in the system step by step accordingly the programmed control serie. (Remote switch-off)

COUPLING:

Mode for coupling of two systems via system-interface (LAN-cable). The systems will work symmetrically. (Refer example page 25)

27 HARMONICS (harmonic limit) [7]% (0.5 ... 25,5)%

A limit for the total harmonic distortion THD-V (in%) can be entered here. When this threshold is exceeded, a message is given. THD-V is the ratio of the geometric sum of the uneven harmonics to the fundamental. A warning is always shown in the display; an output via message relay only takes place when this was selected under point 14.

BASIC SETTING: [NO] (YES / NO)

When the selection is made with YES and confirmed with ENTER, all parameters are reset to the basic setting made by the PFC-system manufacturer.

(Optimal network values when the controller was supplied with a complete PFC-system). If the controller is supplied from the works, this point corresponds to the default setting. **CAUTION: All user settings are lost!**

5.3 Programming lock

The BR6000 is equipped with a programming lock to ensure protection from unauthorized or inadvertent changes to the system parameters. The lock can be activated in expert mode. If the lock is active, all parameters can be checked but not changed.

Section 6 Manual operation (initial operation, maintenance, service) Programming of fixed stages

In manual operation, capacitor branches can be connected/disconnected **in the set control series and switching time** - irrespective of prevailing power-line conditions. The starting condition is STOPP (no stages connected). Connections are made by pressing the **↑** key. Pressing **↓** initially leads back to STOPP mode. Repeated pressing of **↓** leads to the disconnection of stages. The active operating status and active power factor are always shown on the display (self-explanatory).

Manual operation

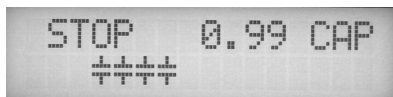
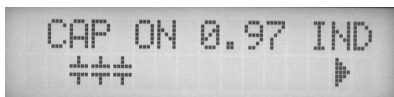

Pressing ENTER takes the user to the menu point "Programming of fixed stages". In the normal case, all stages are programmed for automatic operation (default setting).

Setting of fixed stages

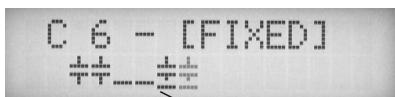

AUTO OFF FIX (Currently selected stage blinks)

In special cases, all controller outputs (C1 - C12) may be permanently defined in succession (continued switching via ENTER) for the following statuses:

AUTO: Automatic (normal) operation

The relevant output is marked by a capacitor symbol.

FIXED: The output is continuously connected, e.g. for fixed PFC. The output is marked by an underlined capacitor symbol.

OFF: The output is continuously disconnected - e.g. for temporarily disconnecting a defective capacitor. The capacitor symbol for this output is faded out. Underlining appears.

The active stage is blinking. The required status is set via **↑/↓**. By pressing ENTER, the user saves this step and moves to the next stage.

The programmed statuses for the outputs also remain visible on the display in automatic operation.

After the required settings have been made, pressing the "Operating Mode" key takes the user to the next menu ("Service") or further to "Automatic Operation".

Section 7 Service menu

The service menu is reached by the operating-mode key.

The stored maximum values of the network parameters can be displayed here as well as the number of switching operations of the individual capacitors and their operating time. The desired stages [in square brackets] can be selected via the arrow keys.

In addition, a fault memory is available, in which the last 8 fault states of the system are stored with fault code and in plain text. (This allows, for example, capturing short lived events of overtemperature or overvoltage)

Action	Display
ENTER	1 min/max. VOLTAGE in V
ENTER	2 max. REACTIVE POWER in kvar
ENTER	3 max. ACTIVE POWER in kW
ENTER	4 max. APPARENT POWER in kVA
ENTER	5 max. TEMPERATURE in °C / °F
ENTER	6 max. THD - V / THD - I in %
ENTER	7 RESET the maximum and energy values
ENTER	8 SWITCHING OPERATIONS C [1] - ...
+/-	to C [12]
ENTER	9 OPERATING TIME C [1] - ... in h
+/-	to C [12]
ENTER	ERROR MEMORY E [1] - in plaintext
ENTER	ERROR MEMORY RESET
ENTER	TEST RUN
ENTER	C-POWER (only after a test-run or AUTO-INIT)
ENTER	Back to 1

TEST-RUN

This menu point allows the user to check the settings of the PFC controller. After activation of the test run, the controller switches each stage on and off successively and calculates the output of the capacitors connected (this procedure is done three times to eliminate possible errors). The values calculated are stored and can be retrieved in the following menu item (C-POWER). At the same time, a plausibility check is conducted with the values programmed.

Any discrepancies found are evaluated and displayed in plain text. The following errors can be displayed:

- No measuring voltage present
- Measuring voltage too high - check programming
- Measuring voltage too low - check programming
- No measuring current? - Short circuit link in current transformer?
- Phase angle current transformer? k/l or phase transposed ?
- Current transformer ratio / 1. Step power wrong ?
- Control series? - check programming
- End stop? - check programming
- Capacitor defect or wrong power input

Note: The results displayed are messages intended to help the user trace the cause of the error. Final evaluation remains the responsibility of the user. Under complicated (high load fluctuations) grid conditions, 100% error recognition cannot be guaranteed.

Section 8 Expert mode 1 and 2

The expert mode is meant for the adjustment of values which normally should not be changed. As a protection against mal-operation this level has an access code branching out in Expert mode 1 or 2.

Password: Expert mode 1: "6343" Expert mode 2: "2244"

8.1. Expert mode 1

- 2 BASIC SETTING NEW** [NO] (available: NO/YES)
Storage of active programming as a new basic setting (usually performed by the PFC-system manufacturer). Caution: The original values are overwritten in the process!
- 3 SWITCHING OPERATIONS RESET** [NO] (available: NO/YES)
The stored switching operations of all capacitor stages are reset to zero. Caution: No information is then available about the switching frequency of the stages and thus the status of the network. (Reset of individual stages in Expert-mode 2)
- 4 OPERATING TIME RESET** [NO] (available: NO/YES)
The stored operating times of all outputs are set to zero.
(Reset of individual stages in Expert-mode 2)
- 5 INTEGRATION TIME** [1] s (1...255 sec.)
The integration time (the time required to form the mean values of a measurement) can be changed for special applications.
- 6 SWITCHING POWER max** [100] kvar (multiples of the smallest stage)
This factor specifies the maximum power which may be switched in one switching step. It can be used to control the intelligent control system, which switches several stages as a function of the power-factor requirement.
- 7 SWITCH.TRIGGER** [66]% (30...100%)
Threshold for switching on of next stage. It should not be changed in the normal case!
- 8 OPERATING LOCK** [NO] (NO / YES / 24H)
24H means, that it will be locked automatically after 24 hours
- 9 SWITCHING OPERATIONS WARNING** [50000] (1000 ... 255000)
After an output has performed this number of switching operations, a warning message is displayed. (Abrasion of capacitor contactors and capacitors)
- 10 FAST DISCHARGE** [NO] (NO or X for the desired stages)
If only some stages of a network are equipped with fast discharge equipment, those stages can here be indicated with X. In this case, the desired discharge time for these stages can be specified in the next menu point. Otherwise, menu point 11 is omitted.
- 11 DISCHARGE TIME** [1] s (1s ..programmed normal discharge time)
Only available when fast discharge is programmed. The specified discharge time is then also included in the normal display.

- 12 PHASE I** [0°]
[L1] - L1 - N] Adjustment of current phase position
- 13 PHASE V** [0°]
L1 - [L1 - N] Adjustment of voltage phase position
- Phase correction between voltage and current in the measuring system. (refer p.6)
- 14 C-TEST** [YES] (YES / NO)
The power of the particular capacitor stage is calculated during each switching operation and compared with the stage output of the capacitor. If the result varies from the nominal value, an error message is generated. This test can be stopped here.
- 15 C-FAULT** [40] % (10...75 %)
The deviation from the rated value of the capacitor, for which a fault message is generated, can be specified here (see point 14)
- 16 TEST ATTEMPTS** [5] (1...9)
When at least this number of successive measurements has resulted in a fault in the capacitor power, a C-fault message is output.
- 17 OUTPUT 1. STEP** [0...255] (0...2550)
The range for entering the stage output can be increased to [0...2550] here, (e.g. for medium voltage measurement)
- 18 CONTROL [3] PHASE** (3 / 1)
The measuring system of the controller is generally based on single-phase measurement. For all standard settings (three-phase), the measurement is converted and all outputs displayed as three-phase values (symmetry in grid assumed). In the single-phase setting, display and control apply only to the single-phase value measured (application: single-phase correction in asymmetrical grids)
- 19 DISPLAY $\cos \varphi$ / $\tan \varphi$** (switch over between cosinus or tangens φ in the display)
- 20 PROTOCOL** *only with option .../S (interface)
[----] not activated
[MODBUS KTR]
[MODBUS RTU] MODBUS protocol for individual usage
[ASCII OUT] output of grid-values as ASCII-file (s.page 20)
[MASTER MMI6000] when using the MMI6000 for measurement of PFC-current
[MASTER MMI7000] when using the MMI7000 for measurement of PFC-current
[EXTERN] for usage of an external measuring device (MMI7000/6000)
[SLAVE HYBRID] operating mode as slave in hybrid-systems - refer p.26
[SLAVE MODE] for coupling of several controllers via interface - refer p.26
[MASTER MODE] see above

Depending on the protocol selection, the appropriate configuration-menu is offered:

- 21 BAUD RATE** [9600/NONE] (4800...38400) Transmission /Parity
22 ADDRESS [1] (1 ... 32) Address
23 Number of MMI [1] (1 ... 9) Nos of connected MMI
24 UPPER VALUE [130]% (110 ...200%) Switch. threshold MMI
25 LOWER VALUE [60]% (40 ... 90%) Switch. threshold MMI
26 ASCII time [10]sec. (1...255 sec) Repetition-time ASCII
27 Type ext.device [MMI7000] (MMI7000 / MMI6000)

8.2. Expert mode 2 (Password: 2244)

The additional 2nd expert mode includes all messages for operation, warning and error which are displayed by the BR6000. Here they may be deactivated separately. When deactivated, the indication of the message in the display as well as possible activation of the relay or effects on the control behavior are suppressed (detailed list of all messages s. menu plan last page).

Also, the alarm relay may be programmed here as 7. / 13. stage. Switching operations/operation time of the capacitors can be set back separately.

EXPERT MODE 2 [YES] (YES/NO)

2 ALARM RELAY (ERROR) (Error / 7.or 13. stage / Message relay)

Selection whether the alarm relay should be used for error message or as additional 7th or 13th stage or as message relay for the standard controller of 6 and 12 steps.

Activation of particular operation, warning and error messages (s. above) (23 messages in total)

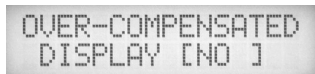

3 ALARM DELAY TIME [10] min. (1...255min.)
Time after which the alarm relay will respond

4 UNDERVOLTAGE [50] % (20 ...100 %)
meas. voltage below this threshold will switch OFF all stages at the same time

5 OVERVOLTAGE [115] % (105 ...140 %)
meas. voltage above this threshold will switch OFF the stages step by step

If measure voltage returns to the permissible range, stages will switch ON again.

6 FREQUENCY [40...80 Hz] (50Hz / 60Hz)
Measurement by the controller is done automatically in grids of 40 ... 80 Hz.
In grids with extremely poor voltage quality it is recommend to select a fix frequency (50 or 60 Hz) to avoid measuring errors due to voltage sags.

7 SWITCH. OPERATIONS C 1 RESET [NO] (YES/NO)
to
C12 RESET [NO] (YES/NO)
Reset of switching operations of particular capacitors possible,
e.g. after replacement of particular capacitors or contactors

8 OPERATION TIME C 1 RESET [NO] (YES/NO)
to
C12 RESET [NO] (YES/NO)
Reset of operation time of particular capacitors possible,
e.g. after replacement of particular capacitors

Section 9 Control principle

The control response of the BR6000 can be selected in programming mode. In principle, the controller has four different control modes:

1. Sequential connection

In sequential connection, the required capacitor stages are successively connected and disconnected in stages (last in - first out). The ranking of each step always corresponds to the power of the smallest stage.

Advantage: Exact definition of the next capacitor to be connected in each case

Disadvantage: Long settling time, high switching frequency of the small stages

In order to shorten the settling time, the BR6000 switches several stages simultaneously for a large power-factor requirement. This applies to all control types. The maximum dimensions of the simultaneously switching branches can be changed in expert mode. If the value of the smallest stage is pre-selected, the conventional sequential connection is obtained.

2. Loop connection

In this variant, the controller operates in loop mode (first in - first out) which minimizes the wear on the capacitor bank, i.e. where stages are of equivalent dimensions, the stage which was disconnected for the longest period of time is always connected next.

Advantage: Balanced utilization of equivalent stages and thus an increased operating life of the capacitor bank.

Disadvantage: This mode can only be used in control series with groups of the same stage power and long settling time, as every switching step corresponds to the value of the smallest stage.

3. Intelligent loop connection (default setting)

The intelligent control principle combines the advantages of the network-sparing loop connection (first in - first out) with a much faster settling time, even for large load skips, and reaches this goal with the fewest possible switching operations of the capacitor stages. The optimized time response is achieved by the simultaneous switching of several or larger capacitor groups as a function of the missing power factor in the power line. Both the number of real switching frequencies of the capacitors as well as the turn-on times of the branches are considered.

Advantage: Reaches the target cos phi in a fast-optimized settling time with a low switching frequency of the capacitors.

4. Combined de-tuning (special case for combined de-tuned banks)

Within a combined de-tuned application, 2 adjoining equal steps are switched with just one joint choke. This pairwise de-tuning requires an appropriate closed control series (i.e. 1:1:1:1..., 1:1:2:2..., 1:1:2:2:4:4... or similar)

The condition for the switching behavior is defined in such a way that the number of activated odd steps is always greater than or equal to the number of activated even steps. The controller complies with the requirements of the control regime while largely conforming to the intelligent switching behavior.

Section 10 Interface *(option)

The BR6000 is equipped with an RS 485 interface as an option. It can be used to implement the following functions:

- ☑ Full parametrization of the controller via a PC
- ☑ Remote read-out of all parameters during operation and displays via a PC Display, logging and analysis of all grid parameters with software "BR7000-Soft" (version 5) for Windows. (see separate description of the software)
- ☑ Connection of system accessories - e.g. data-logger with RJ45 interface
- ☑ Selection of MODBUS (see Annex 5) or ASCII (see table below) for permanent display of grid parameters in ASCII format). Any ASCII editor can be used.

Using with MMI6000 e.g. for measurement of inherent current of capacitor bank or for current measuring at a long distance between CT and BR6000

The following data are permanently displayed and refreshed via ASCII (ASCII Protocol):

Voltage	e.g.	"230 V"	
Current	e.g.	" 85 A"	
Power factor	e.g.	"-0.98"	means: CAP
Reactive power	e.g.	"100 kvar"	
Active power	e.g.	"100 kW"	
Apparent power	e.g.	"100 kVA"	
Outputs	e.g.	"XXX-----"	means: 3 steps active
Max./min. values			

An individual configuration of the ASCII-protocol is possible in expert-mode 1: points 26 and following.

For the bus-connection a shielded cable has to be used!
 Bus-connections (in and out) have always to be made directly to the relevant device!
 In case of "point-to-point" connection the terminating resistors inside the connected devices have to be activated (DIP-switch ON).

Section 11 Initial operation

The controller must have been installed before being set up and operated. All network-specific parameters are fully programmed as described in section 5 (Programming) by being entered in sequence and stored. The controller is then set to automatic operation with the operating mode key. It is now ready for operation.

Section 12 Maintenance and warranty

The BR6000 should need no maintenance if the operating conditions are observed. However, it is recommended that a functional check of the controller be performed in conjunction with the regular checking of the capacitor bank. In the event of any interventions in the controller during the warranty period, all warranty claims lapse.

Section 13 Troubleshooting

Fault	Check / Solution
At target $\cos \phi = 1$ and inductive load, switch-off or connection of capacitor in the corrected line Supply / Drawing mismatched Wrong line $\cos \phi$ is displayed	Check terminals of the measuring voltage and current (l and k)! Check phase position
Display: "UNDER CURRENT"	See above
Display: "OVERCURRENT" Alarm relay: after 10 min.	Current in measuring range? Line interruption? Wrong current-converter factor? Current transformer short-circuited?
Display: "UNDERCOMPENSATED" Alarm relay: after 10 min.	Check current-converter ratio Go through measuring current range
Display: "OVERCOMPENSATED" Alarm relay: after 10 min.	Check connection and phase position! All stages connected - target $\cos \phi$ not reached: compensation network sufficiently dimensioned?
Display: "MEASUREMENT VOLTAGE ???" Alarm relay: after 10 min.	Check connection and phase position! Capacitive grid, although all stages disconnected
Display: "OVERTEMPERATURE" Alarm relay: after 10 min.	No measurement voltage!
Stages are disconnected for an inductive line or connected for a capacitive line	Cabinet temperature too high: Outputs are switched off in stages irrespective of power-line conditions
The controller does not connect all stages, or $\cos \phi$ does not change at the last stages In automatic operation, individual stages are not connected or disconnected	If a target $\cos \phi$ is set which deviates from 1 despite an inductive line load, the display < (disconnect stages) may light up. The arrows indicate the control direction and not the line conditions.
In strongly asymmetrically loaded lines, differences may occur between control response and power-factor measurement, as the power factor is measured in single phase.	Check END STOPP !
No operating voltage	Check whether individual stages are programmed as fixed stages or OFF in the "Manual operation / Fixed stages" menu!
	Line measurements allow the most favorable phase for measuring the power factor to be determined. The current converter is set accordingly for the measuring current.
	Note: No display, alarm relay is activated (open)

Section 14 Technical data

Type series	BR6000...
Outputs	6 or 12 (13)
Languages	D / E / ES / RU / NL / CZ / PL / F / PT / TR
Switching power of relay outputs	250 VAC, 1000 W
Number of active outputs	Programmable
Operation and display	Illuminated graphic display 2 x 16 characters with convenient operating level
Number of control series	20
User-defined control series	1
Control principle	Sequential connection, loop connection or self-optimized switching response Four-quadrant operation
Auto-Init	YES
Operating voltage	110...230 VAC +/-15%, 50 / 60Hz
Measuring voltage	30...525 VAC, 50 / 60Hz
Measuring current	X : 5 / 1A selectable
Power drawn	< 5 VA
Sensitivity	20 mA / 10 mA
Target cos phi	0.1 inductive to 0.1 capacitive adjustable
Connecting time	Selectable from 1 sec ... 20 min.
Disconnecting time	Selectable from 1 sec ... 20 min.
Discharge time	Selectable from 1 sec ... 20 min.
Fixed stages/ skipped stages	Programmable
Alarm relay	Standard
No-voltage triggering	Standard
Display of power-line parameters	Power factor, voltage, apparent current, frequency, reactive-, active-, apparent power, missing kvar, temperature, harmonics
Storage of maximum values	Voltage, reactive power, active power, apparent power, temperature, THD-V, THD-I
Storage of switching number	Yes, each output, individual reset possible
Storage of operating time	Yes, each capacitor, individual reset possible
Temperature measurement range	-30°C ... 100°C
Error memory	Last 8 error states are stored
2nd parameter set	Available at version /S
Accuracy	Current, voltage: 1% Reactive-, active-, apparent power: 2%
Housing	Switchboard-integrated housing DIN 43 700, 144 x 144 x 53 mm
Weight	1 kg
Operating ambient temperature	-20 to +60°C
Protection type to DIN 40 050	Front: IP 54, Rear: IP 20
Safety guidelines	IEC 61010-1:2001, EN 61010-1:2001
Sensitivity to interference (industrial areas)	EN 50082-1:1995 IEC 61000-4-2: 8kV IEC 61000-4-4: 4kV
Option /S 485	Interface RS485 Additional external input Additional user programmable message relay

Annex 1: Table of control series

No.	Control series	Loop connection
1	1 : 1 : 1 : 1 : 1 : 1 : 1 : 1 : 1 : 1 : 1 : 1	Possible
2	1 : 2 : 2 : 2 : 2 : 2 : 2 : 2 : 2 : 2 : 2 : 2	Possible
3	1 : 2 : 3 : 3 : 3 : 3 : 3 : 3 : 3 : 3 : 3 : 3	Possible
4	1 : 2 : 3 : 4 : 4 : 4 : 4 : 4 : 4 : 4 : 4 : 4	Possible
5	1 : 2 : 4 : 4 : 4 : 4 : 4 : 4 : 4 : 4 : 4 : 4	Possible
6	1 : 2 : 3 : 6 : 6 : 6 : 6 : 6 : 6 : 6 : 6 : 6	Possible
7	1 : 2 : 4 : 8 : 8 : 8 : 8 : 8 : 8 : 8 : 8 : 8	Possible
8	1 : 1 : 1 : 1 : 2 : 2 : 2 : 2 : 2 : 2 : 2 : 2	Possible
9	1 : 1 : 1 : 1 : 1 : 6 : 6 : 6 : 6 : 6 : 6 : 6	Possible
10	1 : 1 : 2 : 2 : 2 : 2 : 2 : 2 : 2 : 2 : 2 : 2	Possible
11	1 : 1 : 2 : 2 : 2 : 4 : 4 : 4 : 4 : 4 : 4 : 4	Possible
12	1 : 1 : 2 : 2 : 4 : 4 : 4 : 4 : 4 : 4 : 4 : 4	Possible
13	1 : 1 : 1 : 2 : 2 : 2 : 2 : 2 : 2 : 2 : 2 : 2	Possible
14	1 : 1 : 2 : 3 : 3 : 3 : 3 : 3 : 3 : 3 : 3 : 3	Possible
15	1 : 1 : 2 : 4 : 4 : 4 : 4 : 4 : 4 : 4 : 4 : 4	Possible
16	1 : 1 : 2 : 4 : 8 : 8 : 8 : 8 : 8 : 8 : 8 : 8	Possible
17	1 : 2 : 2 : 3 : 3 : 3 : 3 : 3 : 3 : 3 : 3 : 3	Possible
18	1 : 2 : 3 : 4 : 4 : 8 : 8 : 8 : 8 : 8 : 8 : 8	Possible
19	1 : 2 : 2 : 4 : 4 : 4 : 4 : 4 : 4 : 4 : 4 : 4	Possible
20	1 : 2 : 2 : 2 : 4 : 4 : 4 : 4 : 4 : 4 : 4 : 4	Possible
"E"	Control-series editor	Possible

Control-series editor (programming up to a rating of 30)

The control-series editor allows the user to simply define his/her own control series if the required control series is not available for any reason.

The last control series - Control Series E - is selected by pressing the "Programming" key (point 4: Control series) and confirmed with ENTER. This leads to the insertion of an additional menu point in the main menu -> the control-series editor. It may be reached via the "Operating Mode" key.



In the control-series editor, all stages can be set in succession to the desired value with the selection keys \uparrow / \downarrow . The next stage in each case is reached by pressing ENTER.

In the control series editor, the various steps may be programmed up to a rating of 30 (!). The rating >9 is indicated in the display as follows:

10=A, 11=B, 12=C, 13=D, 14=E, 15=F, 16=G 30=U

ALL control series can be generated (even downwards). The customer will decide whether the generated control series is of sense.

The maximum number of stages can be limited by a programmed END STOPP < 12.

Annex 2: Default settings

Note: The following values for the default settings apply only if the controller is supplied directly from the manufacturer. Otherwise, these values may have been replaced by settings made by the manufacturer of the compensation network (optimal values for the relevant network).

No.	Parameter (* as option)	Default setting	Programmed values of this system (to be entered by manufacturer or operator)
0	LANGUAGE	ENGLISH	
1	I CONVERTER prim.	1000 A	
2	I CONVERTER sec.	5 A	
3	END STOPP	12 (6)	
4	CONTROL SERIES	1	
5	CONTROL PRINCIPLE	INTELLIGENT	
6	POWER 1. STAGE	25.00 kvar	
7	TARGET COS-PHI	0.98 IND	
8	MEASURING VOLTAGE	230 V L-N	
9	V- CONVERTER RATIO	- NO -	
10	SWITCH- IN TIME	40 sec.	
11	SWITCH- OFF TIME	40 sec.	
12	DISCHARGE TIME	60 sec.	
13	ALARM TEMP.	55 °C	
14	MESSAGE RELAY *	FAN	
15	TEMP. FAN ON	30 °C	
27	HARMONICS THD-V	7,0 %	
2	2nd parameter set		Default values are the same as in the 1. parameter set
	Capacitor stages	AUTO	
	Password Expert mode 1	6343	Cannot be changed
	Password Expert mode 2	2244	Cannot be changed
	Integration time	1 sec.	
	Trigger value	66%	
	Max.simult.switch.power	4 x smallest stage	
	Operating lock	- NO -	
	Switch.operations warning	50,000	
	Fast discharge	- NO -	
	Phase shift U/I	0 °	
	C - Test	- YES -	
	C - Fail	40 %	
	Test Attempts	5	
	Power 1. stage	0...255 kvar	
	Control	3 - phase	
	Protocol*	MODBUS-RTU	
	Baudrate/Parity*	9600/NONE	
	Address*	1	
	Numbers of MMI6000*	1	* depends on the version
	ASCII delivery time*	10 sec.	

Annex 3: Coupling of two PFC-systems using two PF-controllers BR6000 (no sum current transformer required)

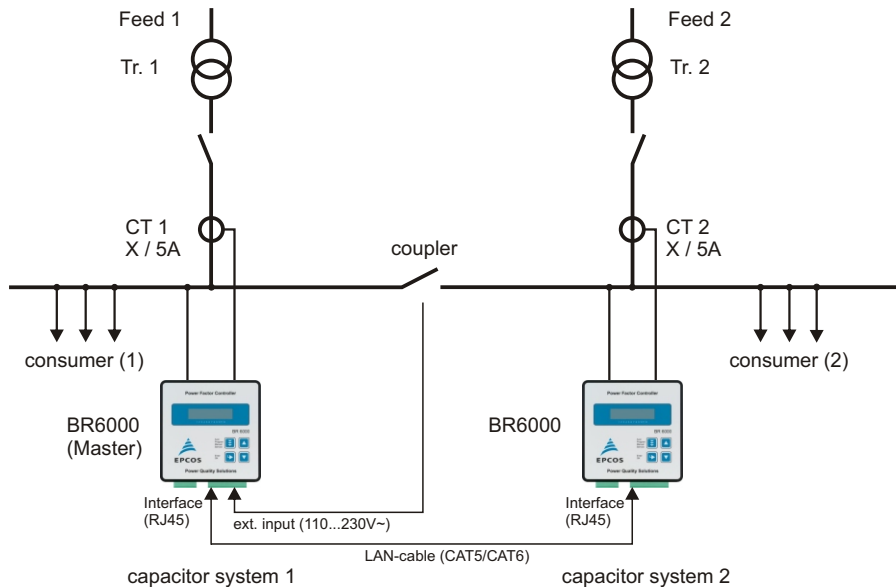

Application example:

Two separate PFC systems installed at two transformers; coupling and decoupling of the two transformer LV grids possible.

- 1) Coupler open: Both systems work completely independent.
- 2) Coupler closed: Due to controller coupling, the two PFC systems are operated in parallel. This operation mode avoid an undesired mutual interaction of the PFC systems when operated at one common busbar (oscillation).
The same power in steps is switched in symmetrically for both PFC-systems.
An optimal operation will be reached by coupling two systems with the same power.

Description:

In case of this controller coupling the currents of both controllers are registered. The measured values are transferred to the "Master", that controls and synchronizes both controllers via interface. No additional installation is necessary.

Installation:

Coupling of two PF-controller BR6000 is done via their system interface via standard LAN-cable CAT5 . The 110...230~ signal "coupler switch closed" has to be input at the external potential free input of one controller (will be the "Master"). This master controller has to be programmed as given here.

Programming:

1. Only to be done at the "Master"-controller:
PROGRAM MODE: 16 EXTERNAL INPUT: COUPLING
2. Controller in the 2nd system:
EXPERT MODE (6343): 19 PROTOCOL: MODBUS RTU
20 BAUDRATE: 38400
21 ADDRESS: 1

No additional settings are required.

Annex 4: Mixed dynamical compensation system and cascading controllers

A mixed dynamical compensation system implements economically the advantages of a dynamic fast network. (Fast changing loads are compensated dynamically and basic loads / slowly changing loads are compensated conventionally)

For designing a mixed-dynamical compensation system a special controller was developed. The BR6000-T6R6 supports up to 6 transistor-outputs (for triggering thyristor modules) and additional 6 relay-outputs for standard capacitor contactors. Please compare the separate manual.

In case more than 6 dynamical and 6 conventional stages or more than 12 standard-stages are required, the following applications are supported.

Coupling of several controllers with each other via interface

A coupling of standard or dynamical controllers (with interface) for creating a hybrid-system with more than 6 outputs or for cascading 2 or 3 standard-controllers is possible from version 5.2 on. Its very easy to use as described below:

Variant1: Hybrid-system with 1 dynamical and 1 or 2 standard controllers

Programming in "Expert-Mode1:"

PROTOCOL:	[Master Hybrid]	[Slave Hybrid]	[Slave Hybrid]
BAUDRATE:	[38400]	[38400]	[38400]
ADDRESS:		[1]	[2]
No of... :	BR6000-R12 [1], [2]		

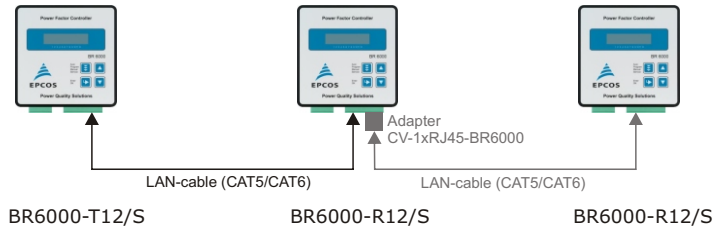

Variant2: Extended-system with 2 or 3 standard controllers in cascade (Extension of the system up to 36 outputs; all controllers will switch symmetrically)

Programming in "Expert-Mode1:"

PROTOCOL:	[Master Mode]	[Slave Mode]	[Slave Mode]
BAUDRATE:	[38400]	[38400]	[38400]
ADDRESS:		[1]	[2]
No of... :	BR6000-R12 [1], [2]		

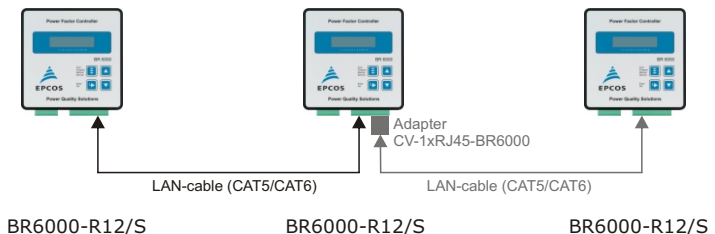

Annex 5: Capacitor current monitoring using MMI6000

Application

For permanent current monitoring inside the compensation system the MMI6000 is recommended as an accessory for the BR6000. This measuring device is able to determine the sum current of the complete PFC system as well as the current of single capacitor branches.

By monitoring the current of the installed capacitors, extraordinary grid conditions (e.g. harmonic currents which may cause an overload of capacitors) can be identified. In such a case, the power factor controller switches off the relevant compensation stages as long as the extraordinary situation continues. Monitoring of the capacitor current also means monitoring of the capacitor condition (damages, aging ...) and thus gives the opportunity to avoid consequential damages.

The MMI6000 will improve the reliability and safety of a PFC-system.

Method of operation:

The MMI6000 measures the sum current inside the PFC system. For this a current transformer has to be installed at the power input of the compensation system. During each switching operation, the actual current change is measured and compared to the rated current of the switched capacitor(s). In between the switching operations the current of the complete system is monitored.

If the measured current of a step is too low (default 60%), this step is switched off. The relay is deactivated and the BR6000 display shows "E" (error) for this step. The alarm relay is activated. A reactivation of the step is possible in manual mode.

In case the current of a step is too high (default 130%), this step is also switched off. The BR6000 display shows an inverted capacitor symbol. The current is further on checked periodically is the rated current reached again, the step is reactivated.

Is the sum current of the complete PFC system too high (default 130%), stages are switched off one after another and alarm relay is set. Periodical measurements are performed to check whether the current reaches the nominal value again. If so, the step is reactivated.

Settings MMI6000:

- Operation mode: Coupling MMI-BR6000
- Grid: 3-phase

Settings BR6000: (ExpertMode)

- Protocol: Master-MMI
- Baud rate
- Number of MMI connected
- Upper limit (%), lower limit (%)
(limits of the capacitor / system output)

Principle circuit diagram:

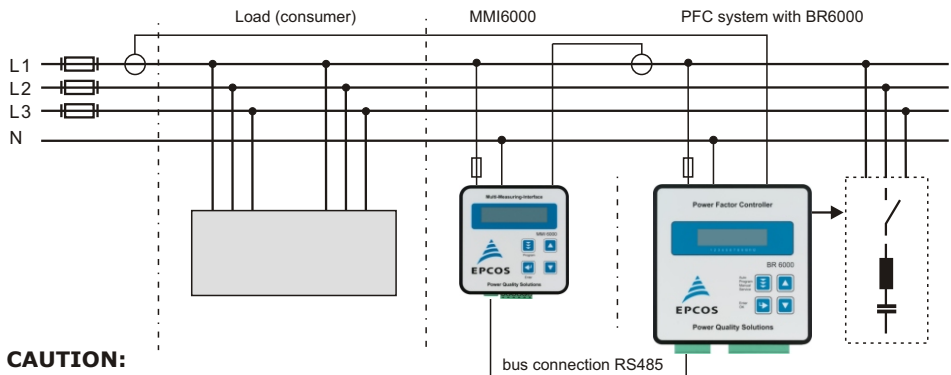

CAUTION:

For the bus-connection a shielded cable has to be used!

Bus-connections (in and out) have always to be made directly to the relevant device!

The terminating resistors inside the connected devices have to be activated (DIP-switch ON).

Annex 6: Register MODBUS Protocol

A detailed description of the MODBUS-protocol parameters (last version) is available at the software-CD, which is included in delivery with each BR6000 device with interface. (BR6000-R12/S485)

MODBUS protocol - example

MODBUS - Functioncode 3 (only-read-register) example meas. voltage				MODBUS - Functioncode 6 (only-write-register) example remote-control (Remote-ON)			
answer				answer			
Byte 1:	Slave Adresse	1	Sl. Address	1	Slave Adresse	1	1
Byte 2:	Functioncode	3	Funct. code	3	Functioncode	6	6
Byte 3:	Reg.start address "H"	0	No of Bytes	2	Registeradr. "H"	0	0
Byte 4:	Reg.start address "L"	20	Data H	0	Registeradr. "L"	40	40
Byte 5:	Reg. number "H"	0	Data L	233	Reg.value H (Data1)	1*	1
Byte 6:	Reg. number "L"	1	CRC L	121	Reg.value L (Data2)	3*	3
Byte 7:	CRC testcode "L"	196	CRC H	202	CRC testcode "L"	72	72
Byte 8:	CRC testcode "H"	14			CRC testcode "H"	83	83

NOTE:

Due to the priority of the control function of the power factor controller before data exchange, please consider that per command 12 consecutive values maximum (s. table) are transferred blockwise. Also, parameters should not be retrieved more than 1 x /second.

Settings: 8 data bit, 1 stop bit, no parity

In "Expert Mode" "\17 Protocol" there are 2 types of Modbus-control:

[MODBUS RTU] Modbus without check (default) - there is no warning, if no valid answer from slave is given

[MODBUS KTR] Modbus with check of valid answer from slave - a warning "MODBUS ERROR" will shown on display, if no valid answer from slave is given within 4 minutes.

For MODBUS KTR: no adjustment of program memory (security interlock)

By pressing the cursor buttons (up / down) the stage display mode can be changed

only available if control serie "E" is selected

AUTO MODE

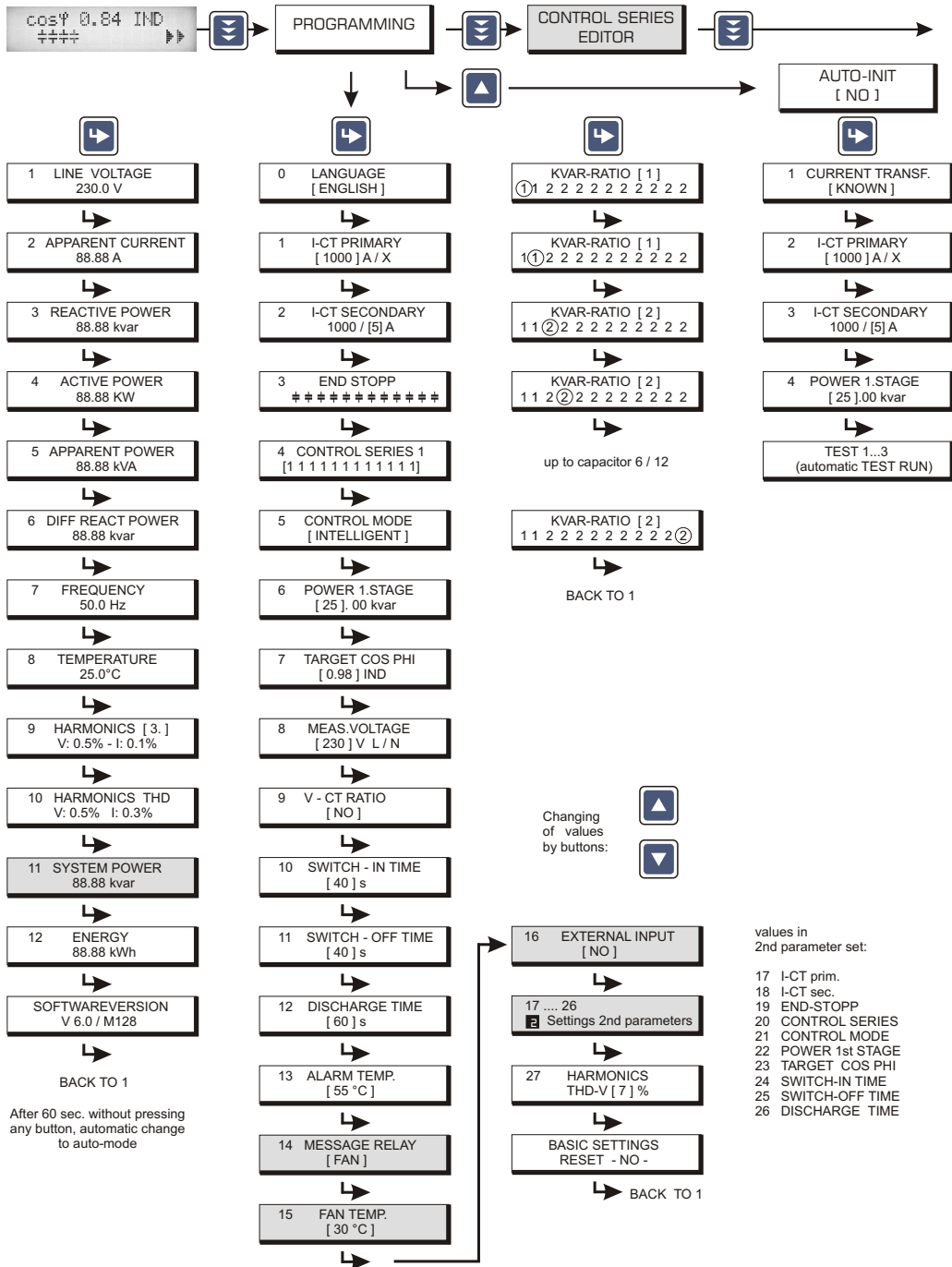

After 60 sec. without pressing any button, automatic change to auto-mode

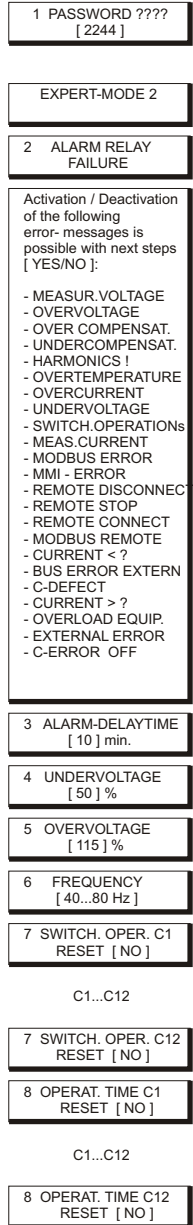
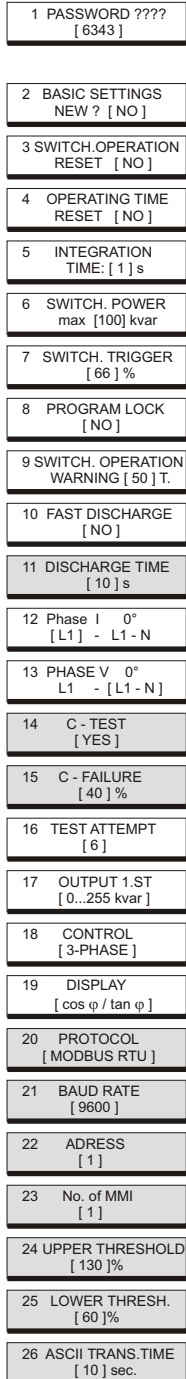
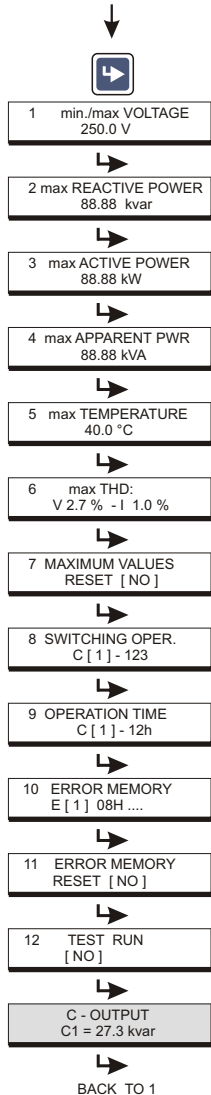
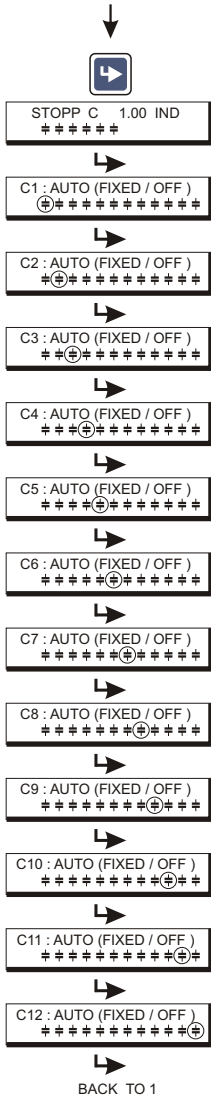

Operating diagram (Brief programming)
Power Factor Controller BR 6000 (V6.0)

Accessories

Multi Measuring Devices
MMI6000 and MMI7000



Data-Logger "DataLog SD"
for BR6000 and BR7000
Recording of all grid- and
system parameters on a
SD memory card



RJ45 adapter connectors for
PF controllers and MMIs.
Terminal to RJ45 converter to
connect the devices via RJ45-
standard cable.

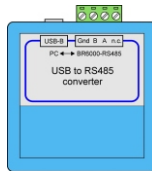

USB to RS485 converter to connect
the PF controllers or other devices
with Interface RS485 to a PC with
USB-interface.

Thyristor-switches
different types: TSM-LC / TSM-HV
10 ... 200kvar / 400 ... 690V

